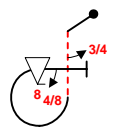
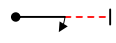
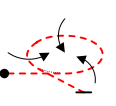
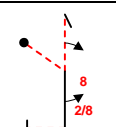
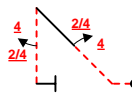
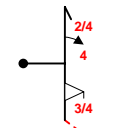
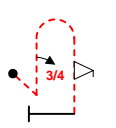
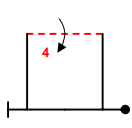
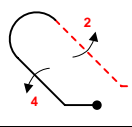
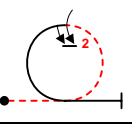
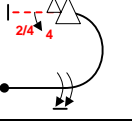

INTERNATIONAL AEROBATIC CLUB SCORESHEET

A	Contest:	Date:	Category:	Programme:	pilot's number	
	U.S. Nationals	2007	Advanced	2nd Unknown		

No	Symbol	Catalogue No.	K	Total K	Score	Remarks
1		8.40.3 9.1.5.3 9.9.3.4 9.8.3.2	13 6 11 7	37		
2		1.1.3 9.1.3.2	2 4	6		
3		2.8.2	18	18		
4		5.1.2 9.1.1.2 9.8.5.1	23 8 3	34		
5		1.15.2 9.4.2.2 9.4.5.2	14 7 5	26		
6		5.1.3 9.4.1.2 9.9.5.3	18 9 11	38		
7		8.2.2 9.1.1.3 9.9.10.2	17 10 13	40		
8		7.7.1 9.4.3.4	14 11	25		
9		8.13.1 9.4.2.4 9.2.4.4	11 13 9	33		
10		7.6.2 9.2.3.6	12 12	24		
11		7.1.1 9.1.3.8 9.9.3.6 9.4.3.2	6 12 14 5	37		
12						

Item	K	Score
Positioning	12	

FIGURE TOTAL K = 318

INCLUDING POSITIONING = 330

Aircraft Type:

FREE PROGRAM CHECKED BY:

Signature:	Date:
IAC No.	

Judge
Name
Number



pilot



B	Contest: U.S. Nationals	Category: Advanced
	Date: 2007	Program: 2nd Unknown

wind direction

Pilot:

NOTE: Y-AXIS ENTRY

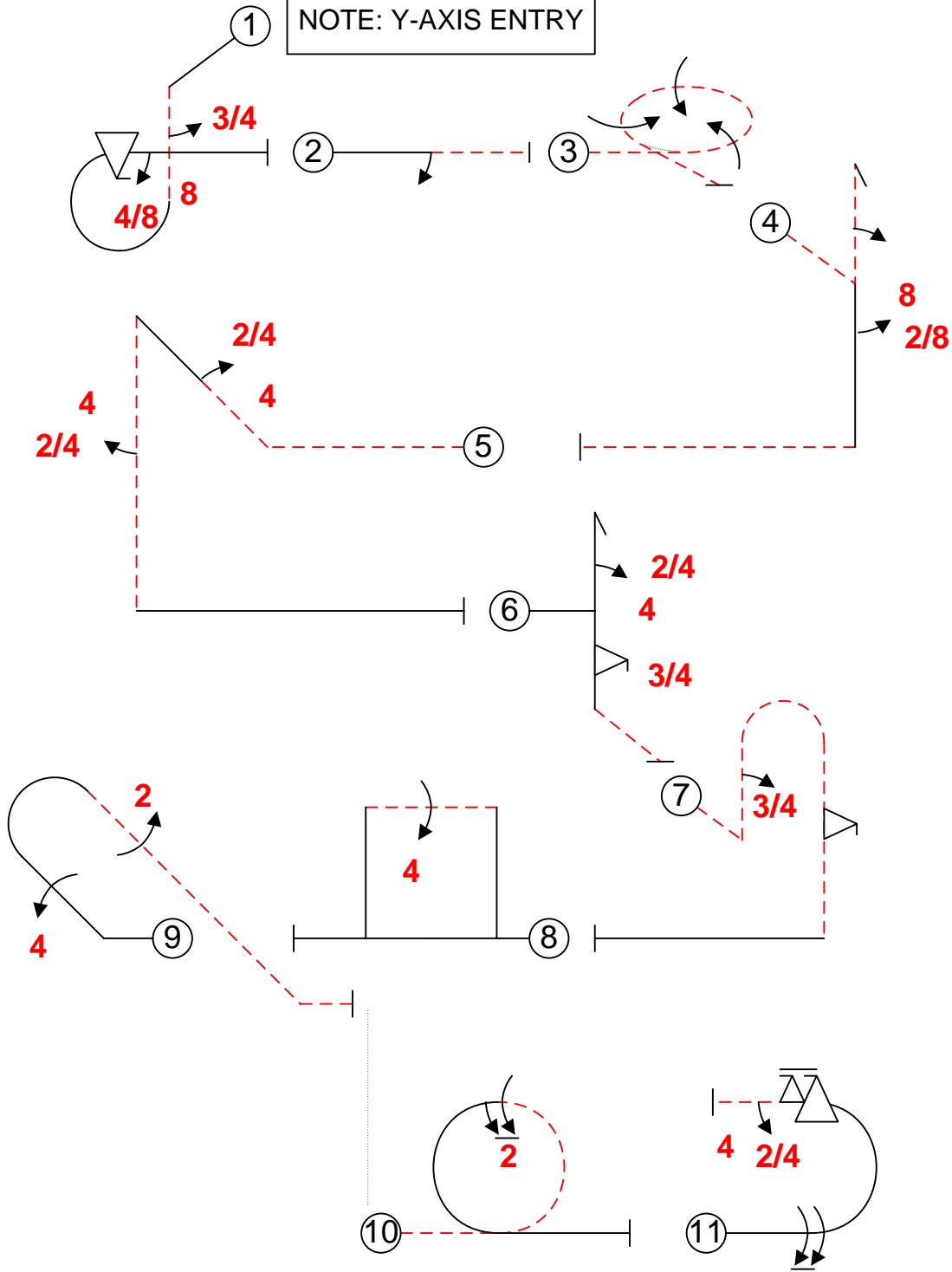

A/C:

(signature/date)

FREE PROGRAM CHECK BY:



C	Contest: U.S. Nationals	Category: Advanced
	Date: 2007	Program: 2nd Unknown

wind direction

Pilot:

NOTE: Y-AXIS ENTRY

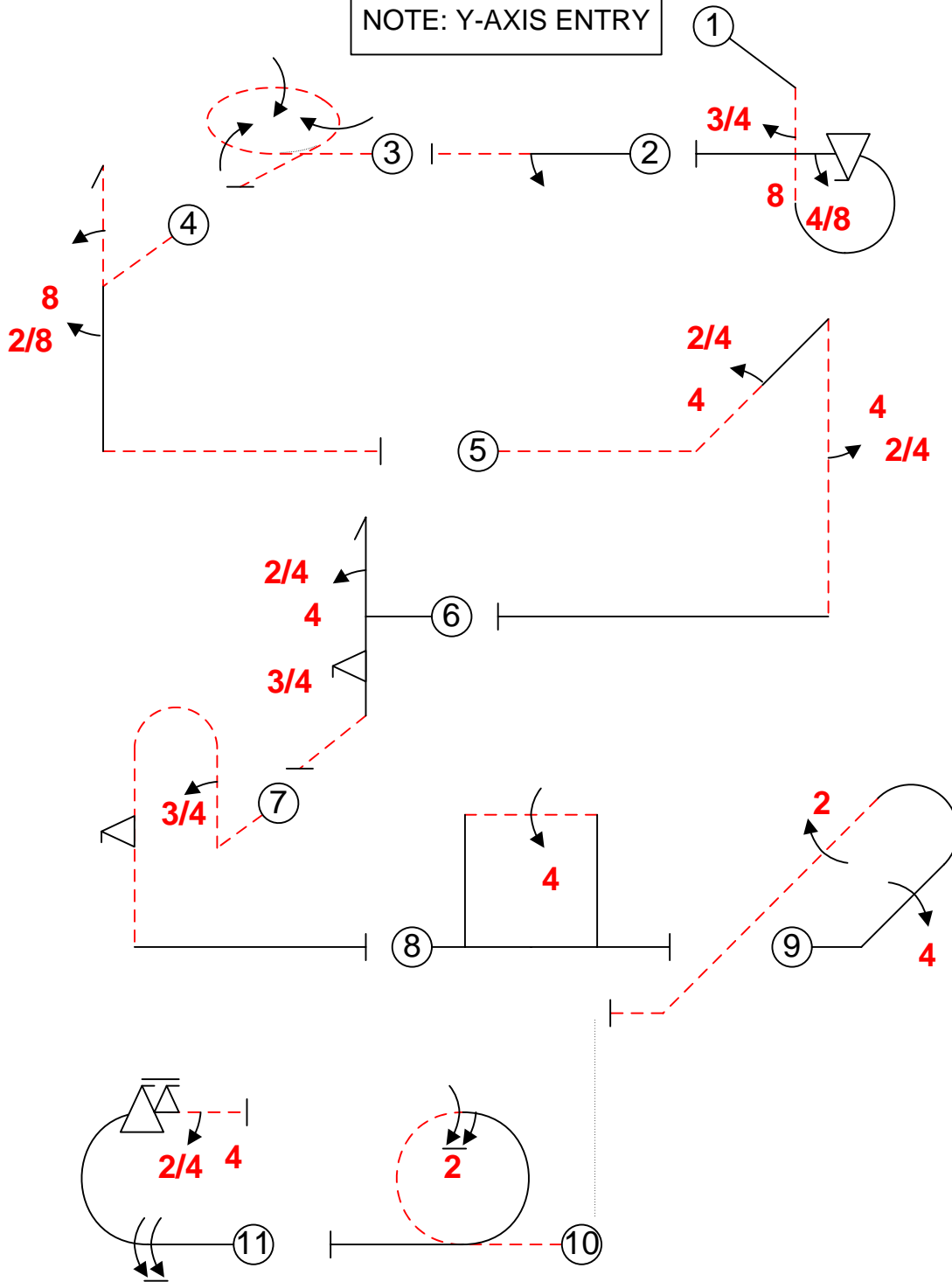

A/C:

(signature/date)

FREE PROGRAM CHECK BY: